

RS 9030

Installation, Operation and Maintenance of Airflex® RH Rotorseal Assemblies



Warning

Forward this manual to the person responsible for Installation, Operation and Maintenance of the product described herein. Without access to this information, faulty Installation, Operation or Maintenance may result in personal injury or equipment damage.

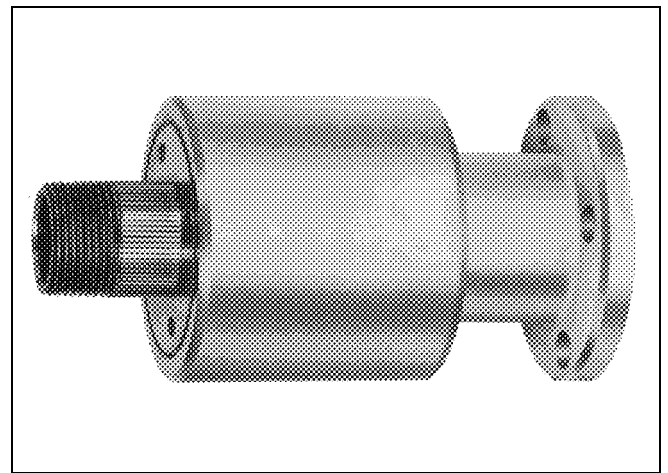

Caution:

Use Only Genuine Airflex® Replacement Parts

The Airflex Division of Eaton Corporation recommends the use of genuine Airflex replacement parts. The use of non-genuine Airflex replacement parts could result in substandard product performance, and may void your Eaton warranty. For optimum performance, contact Airflex:

In the U.S.A. and Canada: **(800) 233-5926**
Outside the U.S.A. and Canada: **(216) 281-2211**

June, 1983

(Revised: December, 2002)

204080

© Copyright Eaton Corp. 2002 All rights reserved.

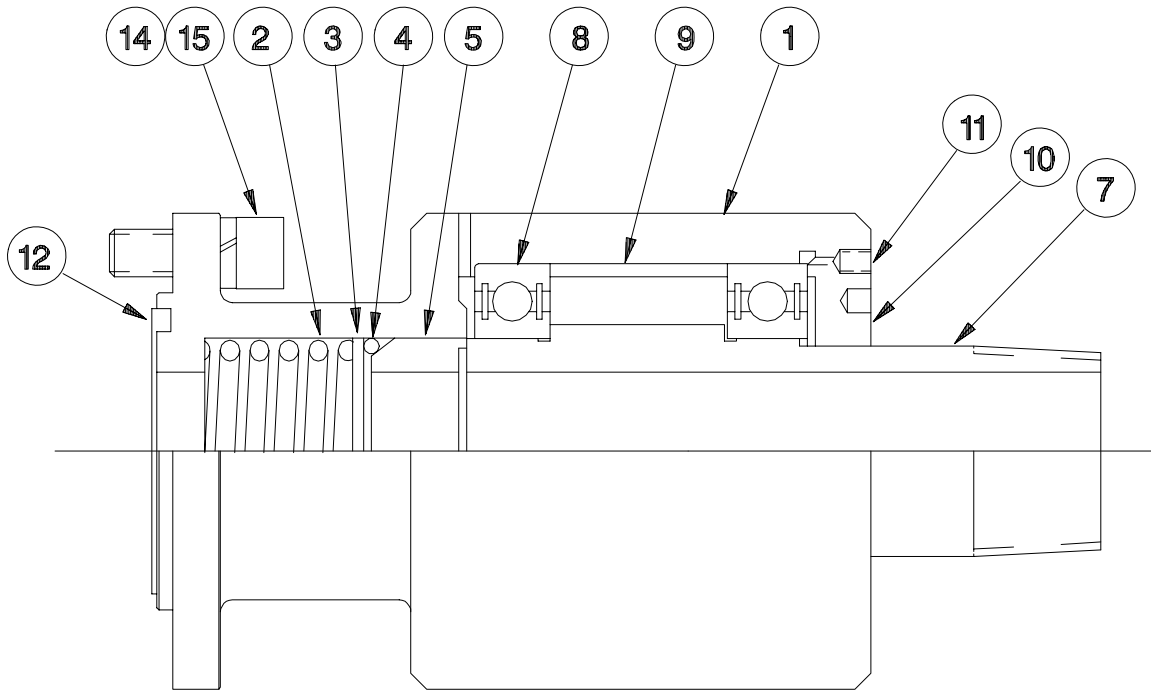



Figure 1

Component Part Numbers							
Item	Qty.	Description	3/4"RH	1"RH	1-1/4"RH	1-1/2"RH	2"RH
---	---	Assembly	145487K	145488K	145489K	145461K	146175
1	1	Housing	305821	305812	305695	412017	510669
* 2	1	Spring	012063	012049	200665	200667	306982
* 3	1	Spring Retainer Washer	012064	012048	012058	010949	203810
* 4	1	Rubber Seal Ring	73 x 208	73 x 37	73 x 414	73 x 103	73 x 330
* 5	1	Carbon Seal	012065	012047	012056	010946	306914
7	2	Shaft	012066	012044	012054	010942	413618
8	1	Ball Bearings	159 x 29	159 x 82	159 x 175	159 x 78	159 x 186
9	1	Bearing Spacer	305823	305824	305825	305826	306912
10	1	Cover	012068	012045	012055	010939	306913
11	1	Set Screw	---	---	---	375 x 5435	---
* 12	1	Rubber Seal	350 x 3	350 x 4	350 x 8	350 x 9	350 x 11
14	4	Lockwasher	31 x 1	31 x 6	31 x 6	68 x 8	68 x 8
15	4	Socket Head Cap Screw	30 x 105	30 x 207	30 x 207	30 x 207	30 x 208
Replacement Kit			145487X	145488X	145489X	145461X	146175X

* These components are included in replacement kit.

1.0 INTRODUCTION

Throughout this manual there are a number of HAZARD WARNINGS that must be read and adhered to in order to prevent possible personal injury and/or damage to the equipment. Three signal words "DANGER", "WARNING", and "CAUTION" are used to indicate the severity of the hazard, and are preceded by the safety alert symbol .

DANGER



Denotes the most serious injury hazard, and is used when serious injury or death WILL result from misuse or failure to follow specific instructions.

WARNING

Used when serious injury or death MAY result from misuse or failure to follow specific instructions.

CAUTION

Used when injury or product/equipment damage may result from misuse or failure to follow specific instructions.

It is the responsibility and the duty of all personnel involved in the installation, operation and maintenance of the equipment on which this device is used to fully understand the  DANGER,  WARNING, and  CAUTION procedures by which hazards are to be avoided.

2.0 OPERATION

2.1 Description

The Airflex single passage rotorseal is a positive seal for introducing air under pressure into a rotating shaft. The rotorseal operates continuously or intermittently at high speeds in either direction. The RH rotorseal has been designed for large air volume applications, available in five sizes having inlet ports suitable for 3/4, 1, 1-1/4, 1-1/2 and 2 inch pipe.

NOTE: Consult the Factory when contemplating the use of Airflex rotorseals with mediums other than air.

2.2 How It Works

The rotating seal of the Airflex rotorseal is established by a lapped surface on the rotating carbon seal (5) that is held against the lapped surface of the stationary shaft (7) by spring (2) pressure. The high quality lapped finish of the contacting surfaces and the applied contact pressure assure a good seal from the stationary member to the rotating member. Air can pass through the bore of the stationary shaft and through the bore of the rotating seal into the machinery shaft or assembly.

2.3 Pressure and Speed Limits

Maximum operating pressure allowable in standard RH rotorseals is 150 psig (10,4 bar). Maximum speed limits are shown on Table 1. Operation at maximum pressure combined with maximum speed should be avoided. Consult the factory or your Airflex Distributor for specific application information.

Size	3/4	1	1-1/4	1-1/2	2
Max RPM	1500	1200	1000	800	600

3.0 INSTALLATION

3.1 Mounting

The Airflex type RH rotorseal is designed for flange mounting to the machinery shaft or assembly. Refer to Figure 2 and Table 3 for mounting dimensions.

3.1.1 Be sure the external rubber seal (12) is properly seated in the rotorseal flange groove before mounting.

3.1.2 Mount the rotorseal and torque the mounting screws to the lubed value indicated in Table 2, using an alternating crosswise pattern.

Size	3/4	1	1-1/4	1-1/2	2
Ft.-Lb.	11	25	25	25	25
Nm	15	34	34	34	34

3.2 Air Connection

The rotorseal shaft (7) has a pipe thread for the inlet air connection. The connection to the rotorseal must always be through a flexible hose, and the air supply piping must be self-supporting. Orientation of the hose in a horizontal position may help in reducing bearing loading. A good pipe thread sealant must be used when connecting the flexible hose to the rotorseal.



Caution:

Rigid air connection will preload the rotorseal bearings, resulting in premature failure.

4.0 MAINTENANCE

A replacement kit is available to allow the rebuilding of the type RH rotorseal (refer to the table under Figure 1). Airflex rotorseals are manufactured with quality materials to precision tolerances. These instructions should be followed carefully to assure a properly repaired rotorseal. Only Airflex rotorseal parts should be used. The rotorseal must be removed from its mounting, and repairs should only be made in a clean, dust-free environment.



Caution:

When replacing components, use only Genuine Airflex replacement parts. Use of other materials may severely effect performance.

4.1 Disassembly

- 4.1.1 The cover (10) is retained in the housing (1) by both staking and the use of Loctite®. Use a flat blade tool to carefully un-stake the cover. It may be necessary to heat the housing slightly to soften the Loctite®. Use a spanner wrench to remove the cover.

Note: The cover on some RH rotorseals is secured with a setscrew and Loctite®. Remove the setscrew prior to attempting to remove the cover.

- 4.1.2 Remove the shaft (7), bearings (8) and bearing spacer (9) from the housing (1) by holding the knurled portion of the shaft in a vise while striking the housing gently with a soft-faced mallet.
Note: Some units do not have a knurled area. In

this case, a pipe union can be temporarily attached to the threaded portion of the shaft to aid in holding the shaft while preventing damage to the shaft. Rotate the housing while striking to reduce binding of the bearings in the housing.

- 4.1.3 Remove the carbon seal (5), rubber seal ring (4), spring retainer washer (3) and spring (2) from the housing. If these parts do not fall freely from the housing, they may be removed with the aid of a wire hook.

4.2 Cleaning and Inspection

- 4.2.1 After disassembly, clean all parts thoroughly using a grease-cutting solvent.



Caution:

Follow proper safety precautions when using solvents.

- 4.2.2 Inspect and check the ball bearings (8). They should be free of rust and contamination, revolve smoothly without binding and show no signs of excessive looseness or wear. Bearings with damaged or leaking seals should be replaced.
- 4.2.3 Inspect the lapped sealing end of the shaft (7) for scoring or pitting. Scoring or pitting will result in leakage. If the disassembly resulted in burrs on the shaft where it was held, remove the burrs.
- 4.2.4 If inspection indicates the shaft or bearings are in poor condition, the shaft, bearings and bearing spacer (9) must be replaced.
- 4.2.5 Inspect the housing and cover for damage. Replace if necessary.

4.3 Assembly

- 4.3.1 Assemble spring (2), spring retainer washer (3), rubber seal (4) and carbon seal as shown in Figure 1. The rubber seal should firmly seat on the chamfered surface of the carbon seal.
- 4.3.2 If the bearings and shaft are replaced, assemble the bearings and bearing spacer to the shaft using proper bearing assembly procedures.



Caution:

When working with the shaft and carbon seal, care must be taken so as not to damage the lapped sealing surfaces.

- 4.3.3 Thoroughly clean the threads on the cover (9) and housing (1) using Loctite® Primer "T".
- 4.3.4 Slide the shaft/bearing subassembly into the housing. Make sure the lapped surfaces are free of dust or dirt.
- 4.3.5 Apply a bead of Loctite® #242 (supplied with repair kit) across the threads of the cover. Assemble the cover, tightening to 50 ft.-lb. (Stake the cover to the housing in four places, 90° apart.
- 4.3.6 Some rotorseals use a setscrew to prevent the cover from loosening during operation. After assembling the cover per the procedures in 4.3.5, install the setscrew in a new location per the following procedures.
 - 4.3.6.1 At the cover/housing interface, drill a #21 (.159" diameter) hole, .25" deep.
 - 4.3.6.2 Tap the hole using a #10-32 NF-3 bottoming tap. Remove any debris from the hole.

- 4.3.6.3 Apply Loctite #242 to the setscrew (11), and assemble. The setscrew should be installed flush or below the surface of the housing after assembly.
- 4.3.7 The replacement kit contains two external sealing rings (12), each with a different cross section, for mounting the rotorseal to the shaft. Select the ring that matches the groove in the mounting flange of the housing (1). Discard the unused ring.
- 4.3.8 Re-install the rotorseal per the instructions in 3.0.

For additional information, note the part number and description on the product label or housing and call or write:

Eaton Corporation
 Airflex Division
 9919 Clinton Road
 Cleveland, OH 44144

Phone: (216) 281-2211
 Fax: (216) 281-3890
 Internet: www.airflex.com

Loctite is a registered trademark of Loctite Corporation.

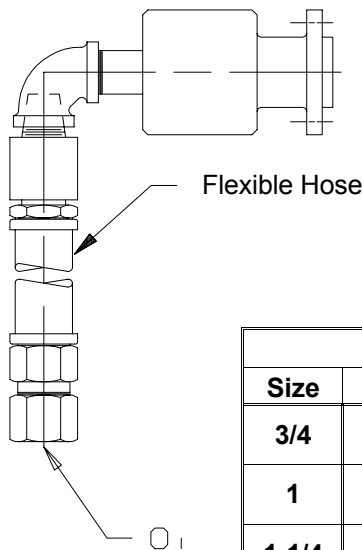

Figure 2

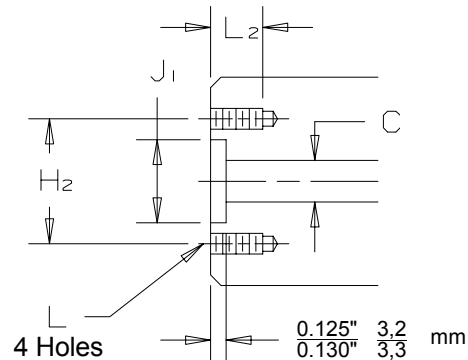

TABLE 3 - MOUNTING DIMENSIONS, INCHES (mm)						
Size	H ₂	J ₁	L (UNC)	L ₂	O	O ₁ (NPT)
3/4	2.375 (60,3)	1.750 (44,5)	5/16-18	0.62 (16)	0.75 (19)	3/4-14
1	2.625 (66,7)	2.000 (50,8)	3/8-16	0.75 (19)	1.00 (25)	1-11 ¹ / ₂
1-1/4	3.125 (79,4)	2.500 (63,5)	3/8-16	0.75 (19)	1.25 (32)	1 ¹ / ₄ -11 ¹ / ₂
1-1/2	3.375 (85,7)	2.750 (69,9)	3/8-16	0.75 (19)	1.50 (38)	1 ¹ / ₂ -11 ¹ / ₂
2	4.250 (108,0)	3.500 (88,9)	3/8-16	0.75 (19)	2.00 (51)	2-11 ¹ / ₂

EATON PRODUCT WARRANTY

Subject to the conditions stated herein, Eaton Corporation warrants to the Purchaser that each new Airflex Product manufactured by Eaton will be free from failures caused by defects in material and workmanship, and will deliver its rated capacity, for a period of twelve (12) months from the date of shipment to Purchaser, provided such Product is properly installed, properly maintained, operated under normal conditions and with competent supervision. Warranty claims shall be made in writing and the part or parts shall, if requested by Airflex Division, be returned prepaid to the Airflex Division for inspection. Upon a determination that a defect exists, Eaton shall thereupon correct any defect, at its option either by repairing any defective part or parts or by making available at Eaton's plant a repaired or replacement part. This warranty does not extend to normal wear parts or components of the Product, such as friction material and friction surfaces.

LIMITATION OF WARRANTY

THE FOREGOING WARRANTY IS EXCLUSIVE AND IN LIEU OF ALL OTHER WARRANTIES WHETHER WRITTEN, ORAL OR IMPLIED. ANY IMPLIED WARRANTY OF MERCHANTABILITY OR FITNESS FOR A PARTICULAR PURPOSE ARE SPECIFICALLY EXCLUDED.

In no event shall Eaton be liable for special, incidental or consequential damages. Eaton's liability arising out of the supplying of such Product, or its use, whether in warranty, contract or otherwise, shall in no case exceed the cost of correcting defects in the Products as herein provided. Upon expiration of the twelve (12) month period, all such liability shall terminate. THE FOREGOING SHALL CONSTITUTE THE SOLE REMEDY OF PURCHASER AND THE SOLE LIABILITY OF EATON.